Tiller Handle Components

Tiller Handle Component Location.....	1
---------------------------------------	---

Lanyard Stop Switch Operation

Lanyard Stop Switch.....	2
--------------------------	---

Tiller Handle Adjustments

Adjustments.....	6
------------------	---

Gear Shifting

Gear Shifting.....	9
--------------------	---

Troll Control (if Equipped)

Troll Control.....	10
--------------------	----

Power Trim

Power Trim.....	12
-----------------	----

Operation

General Information.....	13
Prestarting Instructions.....	13
Starting the Engine.....	14
Stopping the Engine.....	17

Auxiliary Light (if Equipped)

Auxiliary Light (if Equipped)..... 18

TILLER HANDLE COMPONENTS

Tiller Handle Component Location

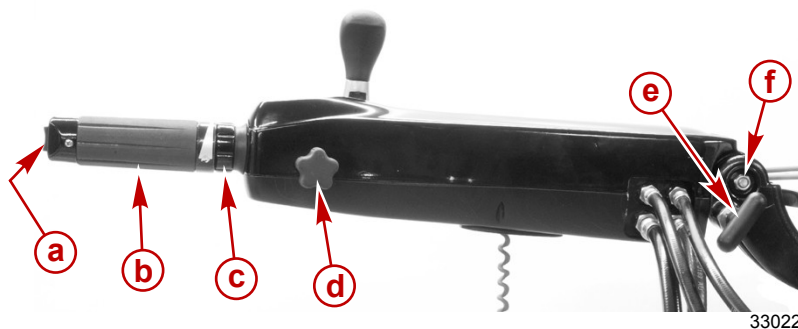

- a** - Power trim switch
- b** - Throttle grip
- c** - Steering actuator adjustment collar (power steering models)
- d** - Throttle grip friction knob
- e** - Tilt lock knob
- f** - Tiller handle tilt friction adjustment bolt

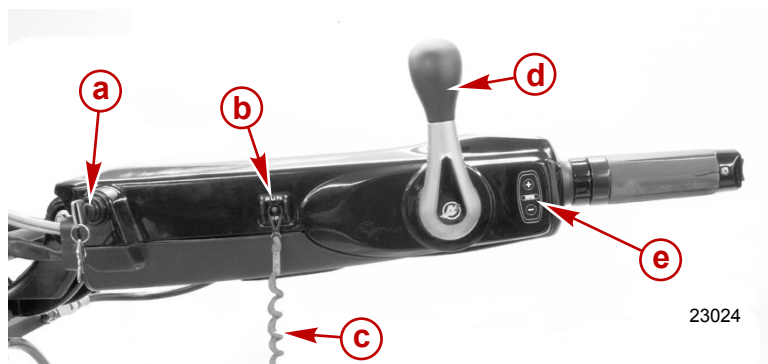

- a** - Ignition key switch
- b** - Lanyard stop switch
- c** - Lanyard
- d** - Gear shift handle
- e** - Troll speed control switch (if equipped)

LANYARD STOP SWITCH OPERATION

Lanyard Stop Switch

The purpose of a lanyard stop switch is to turn off the engine when the operator moves far enough away from the operator's position (as in accidental ejection from the operator's position) to activate the switch. Tiller handle outboards and some remote control units are equipped with a lanyard stop switch. A lanyard stop switch can be installed as an accessory - generally on the dashboard or side adjacent to the operator's position.

The lanyard is a cord usually 122–152 cm (4–5 feet) in length when stretched out, with an element on one end made to be inserted into the switch and a snap on the other end for attaching to the operator. The lanyard is coiled to make its at-rest condition as short as possible to minimize the likelihood of lanyard entanglement with nearby objects. Its stretched-out length is made to minimize the likelihood of accidental activation should the operator choose to move around in an area close to the normal operator's position. If it is desired to have a shorter lanyard, wrap the lanyard around the operator's wrist or leg, or tie a knot in the lanyard.

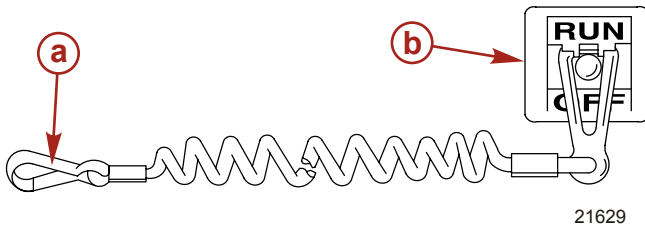

- a** - Lanyard cord
- b** - Lanyard stop switch

Read the following Safety Information before proceeding.

LANYARD STOP SWITCH OPERATION

Important Safety Information: The purpose of a lanyard stop switch is to stop the engine when the operator moves far enough away from the operator's position to activate the switch. This would occur if the operator accidentally falls overboard or moves within the boat a sufficient distance from the operator's position. Falling overboard and accidental ejections are more likely to occur in certain types of boats such as low sided inflatables, bass boats, high performance boats, and light, sensitive handling fishing boats operated by a hand tiller. Falling overboard and accidental ejections are also likely to occur as a result of poor operating practices such as sitting on the back of the seat or gunwale at planing speeds, standing at planing speeds, sitting on elevated fishing boat decks, operating at planing speeds in shallow or obstacle infested waters, releasing your grip on a steering wheel or tiller handle that is pulling in one direction, drinking alcohol or consuming drugs, or daring high speed boat maneuvers.

While activation of the lanyard stop switch will stop the engine immediately, a boat will continue to coast for some distance depending upon the velocity and degree of any turn at shut down. However, the boat will not complete a full circle. While the boat is coasting, it can cause injury to anyone in the boat's path as seriously as the boat would when under power.

LANYARD STOP SWITCH OPERATION

We strongly recommend that other occupants be instructed on proper starting and operating procedures should they be required to operate the engine in an emergency (e.g. if the operator is accidentally ejected).

WARNING

If the operator falls out of the boat, stop the engine immediately to reduce the possibility of serious injury or death from being struck by the boat. Always properly connect the operator to the stop switch using a lanyard.

WARNING

Avoid serious injury or death from deceleration forces resulting from accidental or unintended stop switch activation. The boat operator should never leave the operator's station without first disconnecting the stop switch lanyard from the operator.

Accidental or unintended activation of the switch during normal operation is also a possibility. This could cause any, or all, of the following potentially hazardous situations:

- Occupants could be thrown forward due to unexpected loss of forward motion - a particular concern for passengers in the front of the boat who could be ejected over the bow and possibly struck by the gearcase or propeller.
- Loss of power and directional control in heavy seas, strong current, or high winds.
- Loss of control when docking.

KEEP THE LANYARD STOP SWITCH AND LANYARD CORD IN GOOD OPERATING CONDITION

Before each use, check to ensure the lanyard stop switch works properly. Start the engine and stop it by pulling the lanyard cord. If the engine does not stop, have the switch repaired before operating the boat.

LANYARD STOP SWITCH OPERATION

Before each use, visually inspect the lanyard cord to ensure it is in good working condition and that there are no breaks, cuts, or wear to the cord. Check that the clips on the ends of the cord are in good condition. Replace any damaged or worn lanyard cords.

TILLER HANDLE ADJUSTMENTS

Adjustments

THROTTLE GRIP FRICTION ADJUSTMENT

Turn the throttle grip friction knob to set and maintain the throttle at the desired speed. The throttle grip friction knob can be adjusted to increase or decrease the amount of effort needed to rotate the throttle grip. Turn the knob clockwise to tighten friction or counterclockwise to loosen friction.

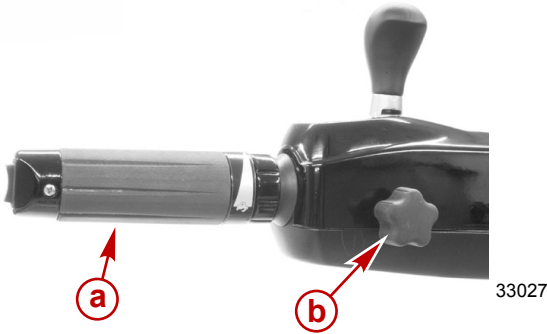

- a** - Throttle grip
- b** - Throttle grip friction knob

STEERING ACTUATOR ADJUSTMENT COLLAR (MODELS WITH POWER STEERING)

Pivoting the throttle grip to the left or right engages the power steering. The collar can be adjusted to increase or decrease the amount of effort needed to pivot the throttle grip. Turn the collar counterclockwise to decrease effort or clockwise to increase effort.

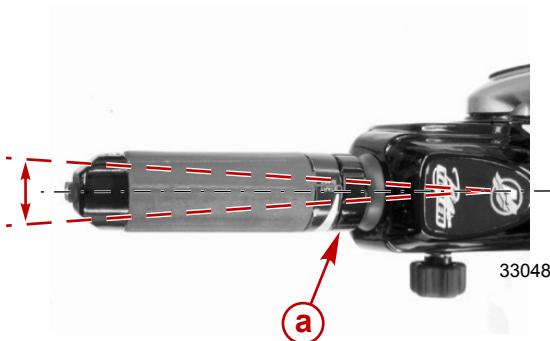

- a** - Steering actuator adjustment collar

TILLER HANDLE ADJUSTMENTS

TILLER HANDLE TILT FRICTION ADJUSTMENT

The tiller handle pivot bolt can be adjusted to increase or decrease the amount of effort needed to move the tiller handle up and down. Loosen the jam nut on the end of the pivot bolt and tighten or loosen the pivot bolt to obtain the desired friction setting on the tiller handle. Hold the pivot bolt from turning and tighten the jam nut to the specified torque.

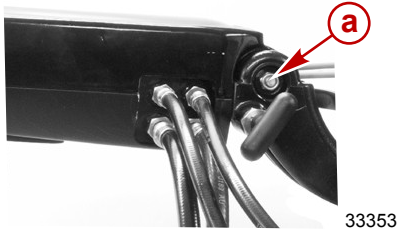

a - Pivot bolt and jam nut

Description	Nm	lb-in.	lb-ft
Tiller handle tilt friction jam nut	47	420	35

TILLER HANDLE ADJUSTMENTS

TILLER HANDLE TILT LOCK

The tilt lock feature allows for the tiller handle to be tilted up and locked in either the mid tilt angle position or full tilt angle position. When using the tilt lock feature, move the tiller handle to the desired position and rotate the tilt lock knob clockwise so that the cross pin will access the through slot. Push in the tilt lock knob to engage the lock. Release the lock by pulling out the tilt lock knob and turning it counterclockwise.

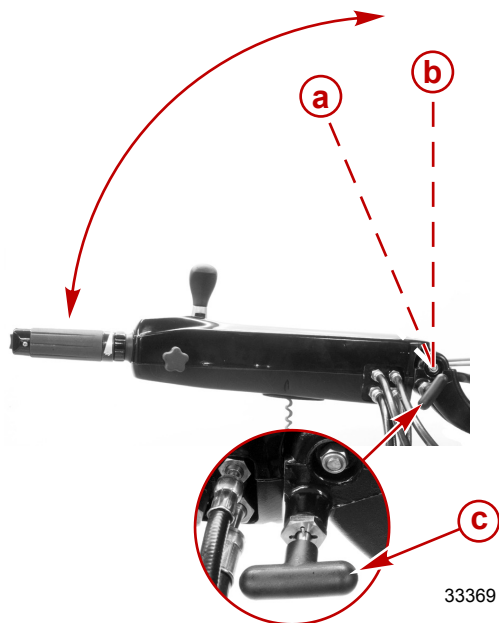

- a** - Mid tilt angle position
- b** - Full tilt angle position
- c** - Tilt lock knob

GEAR SHIFTING

Gear Shifting

IMPORTANT: Observe the following:

- **Never shift outboard into gear unless engine speed is at idle.**
- **Do not shift outboard into reverse when the engine is not running.**
- Your outboard has three gear shift positions to provide operation: forward (F), neutral (N), and reverse (R).
- Reduce engine speed to idle before shifting.
- Always shift outboard into gear with a quick motion.
- After shifting outboard into gear, the throttle grip can be rotated to increase speed.

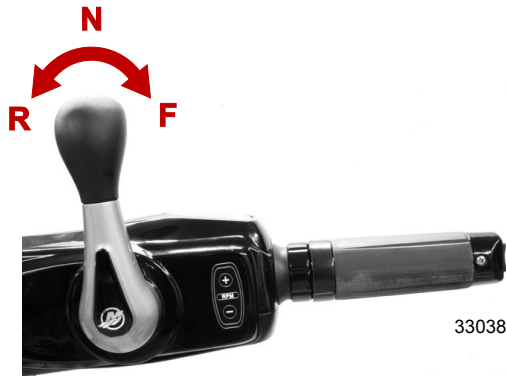

TROLL CONTROL (IF EQUIPPED)

Troll Control

Troll control allows the operator to maintain a set trolling speed without using the throttle. Refer to the following table for the trolling speed range.

Trolling Speed Range	
30–60 hp FourStroke	700–1000 RPM
75–150 hp FourStroke	550–1000 RPM
75–125 OptiMax	650–1000 RPM
135 hp and higher OptiMax	550–1000 RPM
135–200 Verado 4 cylinder	550–1000 RPM

The troll control can be shut off anytime by rotating the throttle grip out of the idle setting, or by moving the shift handle back to neutral.

NOTE: *Slight rotation of the throttle grip while steering the outboard may disengage the troll control. Adjusting the throttle friction may prevent this.*

Turn on the troll control as follows:

1. With the engine running, shift the engine into gear.
2. Set the throttle grip to the "START/SHIFT" position.
3. Press either the (+) or (–) button to turn on the troll control.
4. The RPM light will be illuminated when the troll control is turned on.
5. Press the (+) button to increase troll speed and (–) to decrease troll speed.

Turn off the troll control as follows:

1. Rotate the throttle grip out of the "START/SHIFT" position, or move the shift handle back to neutral.

TROLL CONTROL (IF EQUIPPED)

2. The RPM light will go out when the troll control is turned off.

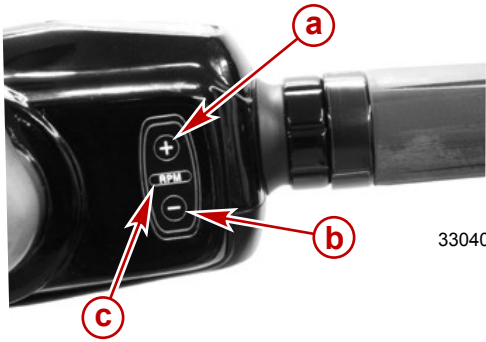

33040

- a** - Speed control button - increase speed
- b** - Speed control button - decrease speed
- c** - RPM light

POWER TRIM

Power Trim

The power trim switch allows the operator to adjust the position of the outboard. Refer to **Power Trim Operation** in the outboard owner's manual.



a - Power trim switch

OPERATION

General Information

ALL MODELS

Never stand on or use the tiller handle as a step.

When the outboard is tilted up to its full range, make sure that the tiller handle will not contact anything that can damage it.

If the tiller handle causes interference when the outboard is tilted up to the full position, a tilt limit kit is available for models 75 hp and higher through Mercury Marine. This kit will limit the upward tilting range of the outboard. Contact your authorized dealer.

POWER STEERING MODELS

The power steering system has a manual steering override feature. This feature allows the operator to steer the outboard in case the power steering pump should ever become inoperative.

Low battery voltage may cause incorrect power steering pump operation.

Under certain operating conditions, a slight shudder may be felt in the throttle grip. This is normal and is caused by a feedback from the power steering pump.

Prestarting Instructions

ALL MODELS

- Before starting, read the prestarting check list, prestarting instructions, and engine break-in procedure in the **Operation** section of the outboard owner's manual.
- Visually check the tiller handle for tightness and the steering system for any loose components.

POWER STEERING MODELS

- Check that the manual steering override feature is functional. Before starting the engine, manually steer the outboard through the entire range. If the outboard cannot be steered manually, the manual steering override feature will not function if needed. Have the outboard checked by your authorized dealer.
- Remove the trailering clips if installed.

OPERATION

Starting the Engine

1. Open the fuel tank vent screw (in filler cap) on the manual venting type fuel tanks.

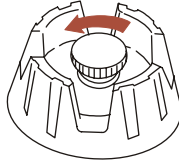

19748

2. Models with primer bulb - Position the fuel line primer bulb so the arrow on the side of the bulb is pointing up. Squeeze the fuel line primer bulb until it feels firm.

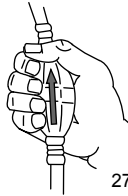

27348

3. Set the lanyard stop switch to the "RUN" position. Refer to **Lanyard Stop Switch Operation**.



19791

OPERATION

4. Shift outboard to neutral ("N") position.

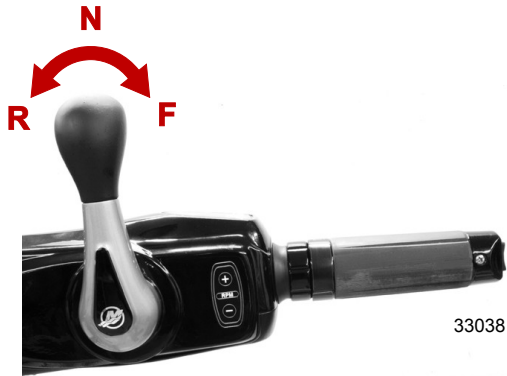

5. Rotate the throttle grip clockwise to the "START/SHIFT" position.
6. Starting a flooded engine - Advance the throttle grip to half throttle position.



NOTE: For initial start of a new engine, or for an engine that ran out of fuel or was drained of fuel, the fuel system should be filled by following the procedure in the **Starting the Outboard** section of the outboard owner's manual.

7. Non-DTS models - Turn the ignition key to the "START" position. If the engine fails to start within ten seconds, return the key to the "ON" position, wait 30 seconds, and try again.

OPERATION

- 150 FourStroke and DTS models - Turn the ignition key to the "START" position and release the key. The electronic starting system will automatically crank the engine for starting. If the engine fails to start, the engine will stop cranking. Turn the key to the "START" position again until the engine starts.

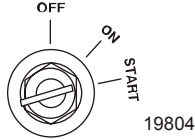

- After the engine starts, check for a steady stream of water flowing out of the water pump indicator hole.

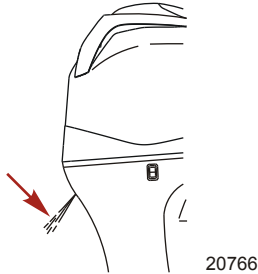

IMPORTANT: If no water is coming out of the water pump indicator hole, stop the engine and check the cooling water intake for obstruction. No obstruction may indicate a water pump failure or blockage in the cooling system. These conditions will cause the engine to overheat. Have the outboard checked by your dealer. Operating the engine while overheated will cause engine damage.

WARMING UP ENGINE

Before beginning operation, allow the engine to warm up at idling speed for three minutes.

OPERATION

Stopping the Engine

Reduce engine speed and shift outboard to neutral position. Turn ignition key to "OFF" position.

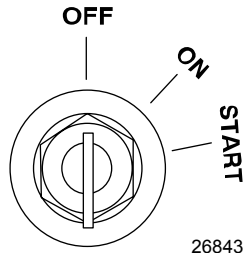

AUXILIARY LIGHT (IF EQUIPPED)

Auxiliary Light (if Equipped)

An auxiliary light is located on the bottom of the tiller handle. The light can be turned on whenever the ignition key switch is in the "ON" or "RUN" position. Turn the light on or off using the light switch in the light housing.

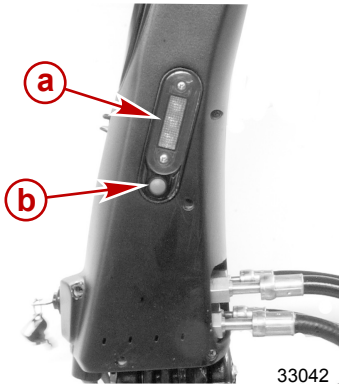

- a** - Auxiliary light
- b** - Light switch

33042